

**Dossier
Wegventielen**

De verschillende ventielen

Wegventielen

2/2-ventiel
3/2-ventiel
4/2-ventiel
5/2-ventiel
4/3-ventiel
5/3-ventiel

Regelventielen

Smoring
Snelheidsregelventiel
Snelontluchter





Terugslagventielen

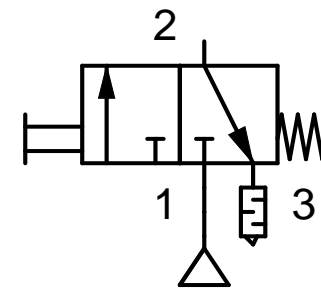
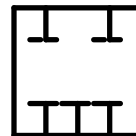
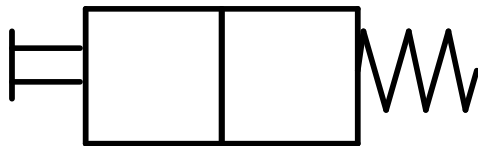
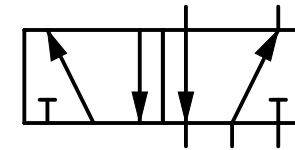
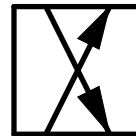



Terugslagklep
Gestuurde terugslagklep
Wisselventiel (OF-functie)
Tweedrukventiel (EN-functie)

De symbolen en hun benaming



De sturingen

Manueel		Handbediening
		Paddelstoelknop
		Hendel
		Voetbediening
		Vergrendeling

Mechanisch		Veer
		Stift
		Rolbediening
		Knikrolbediening

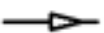
Pneumatisch		Lucht bediening
--------------------	---	-----------------

Elektrisch		Spoel
-------------------	---	-------

Monostabiele en bistabiele ventielen

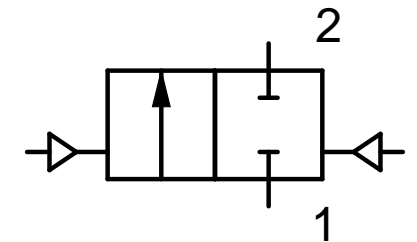
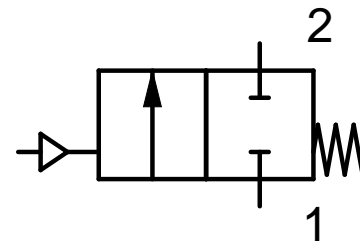
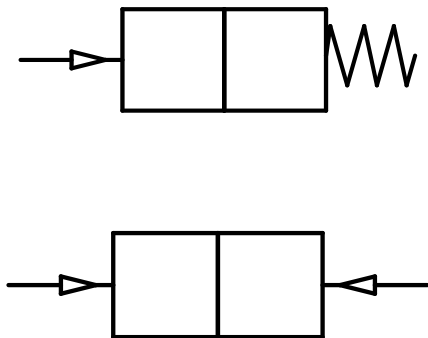

De verschillende ventieltypes

Het 2/2 ventiel

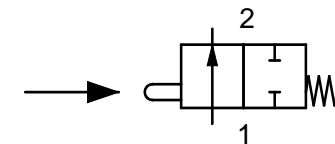
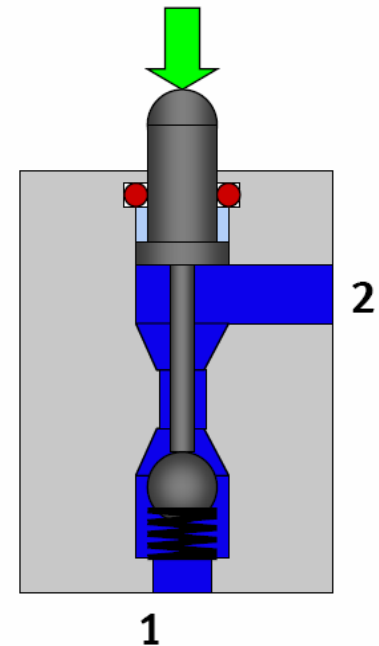
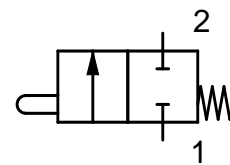
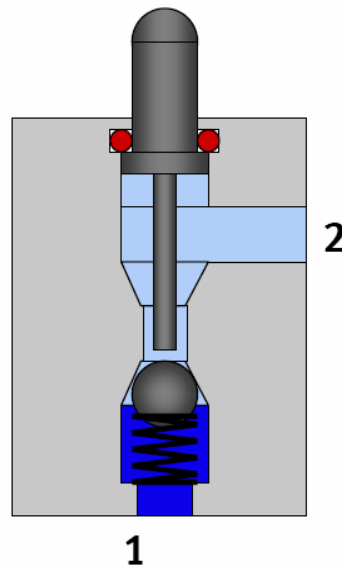
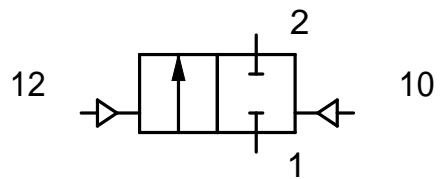
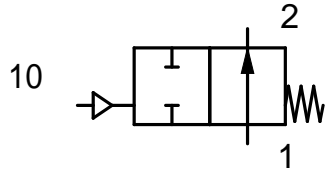
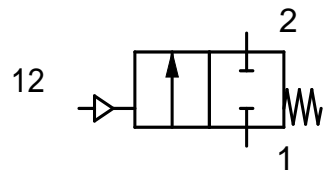

De verschillende ventieltypes

Het 3/2 ventiel

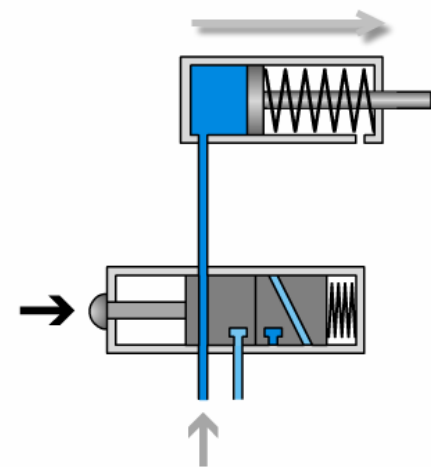
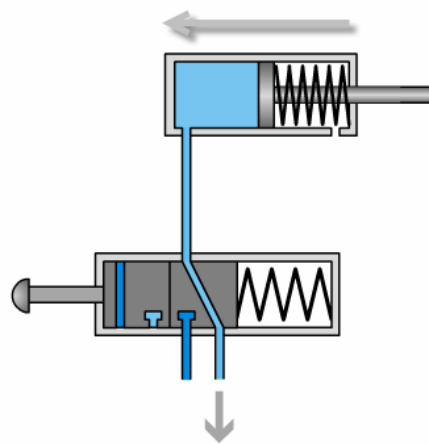
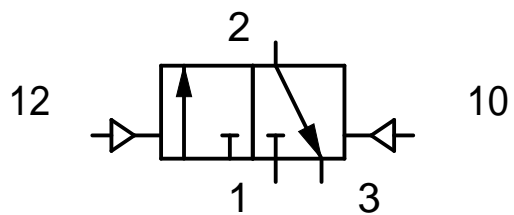
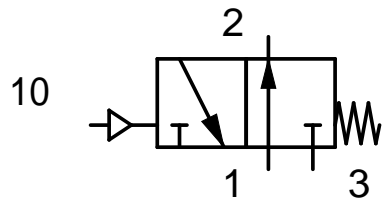
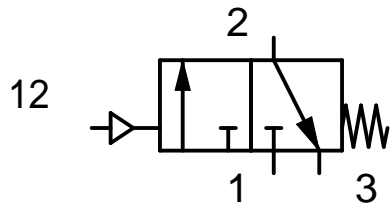

De verschillende ventieltypes

Het 3/2 ventiel

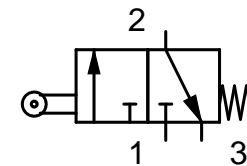
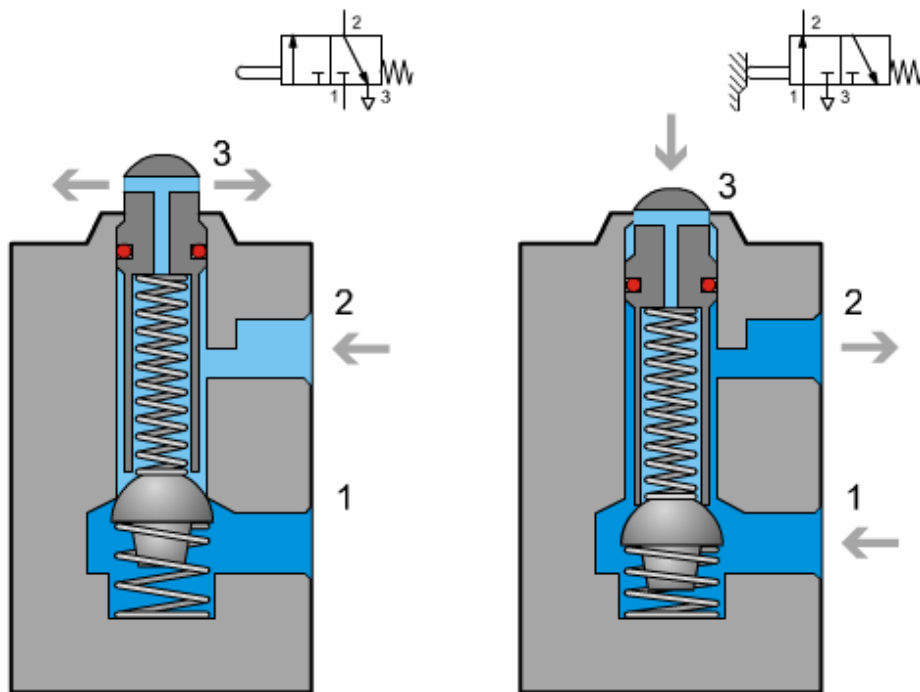

De verschillende ventieltypes

Het 4/2 en het 5/2 ventiel

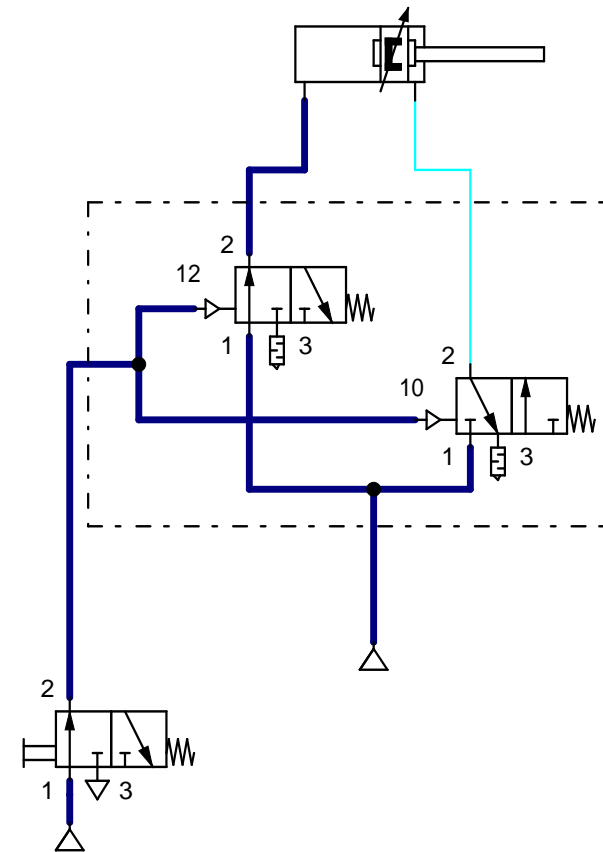
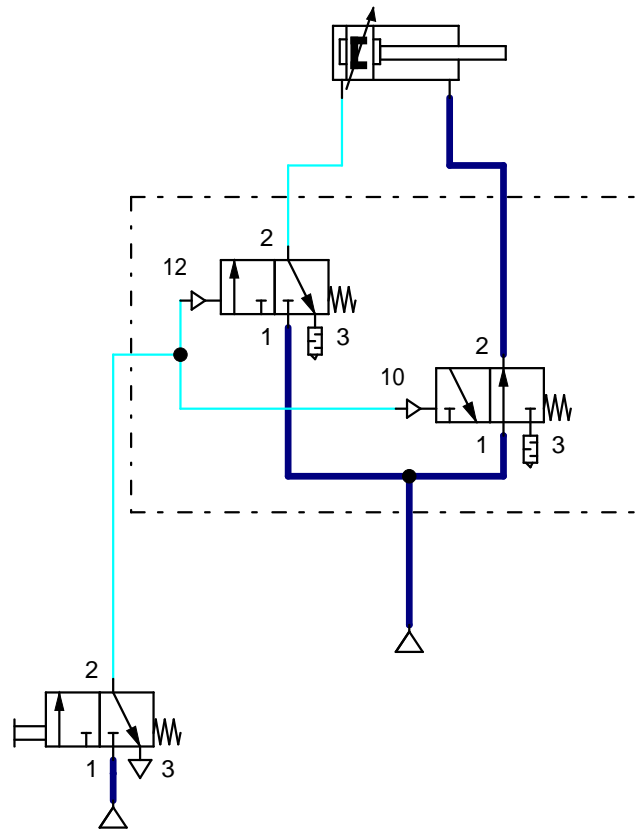

De verschillende ventieltypes

Het 4/2 ventiel

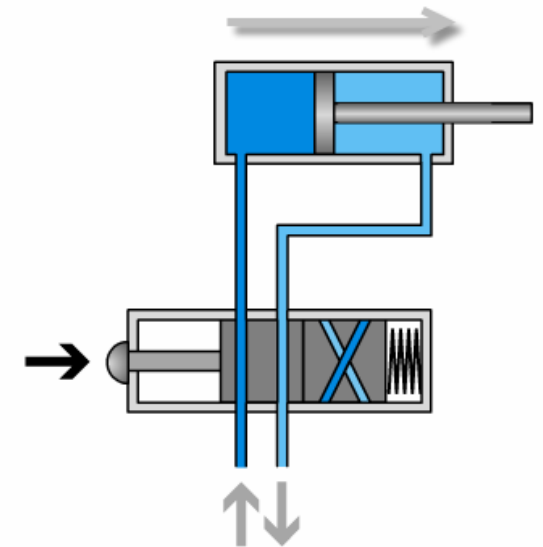
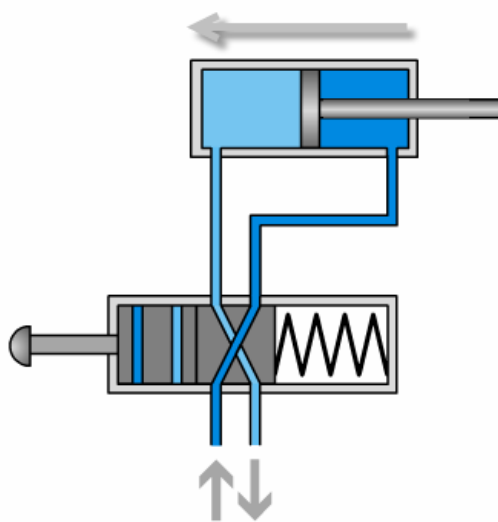
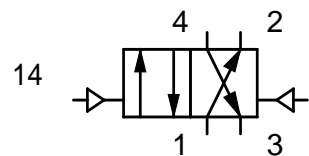
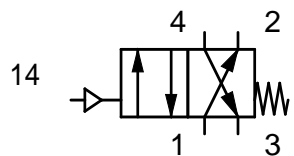
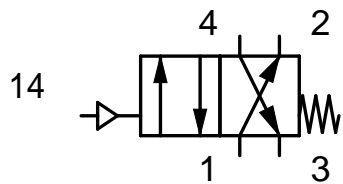
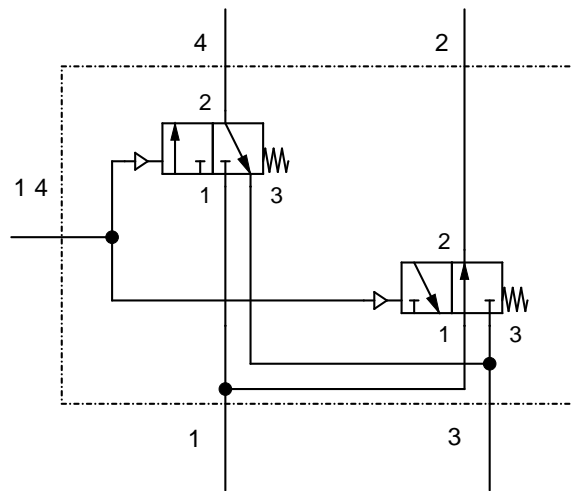

De verschillende ventieltypes

Het 5/2 ventiel

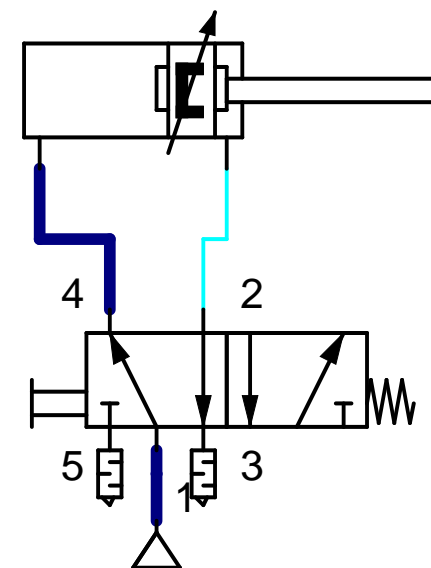
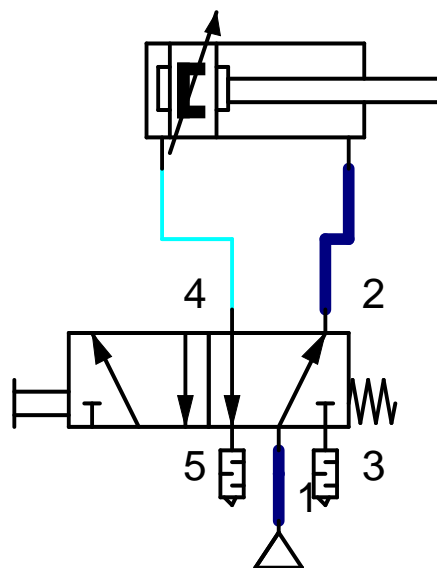
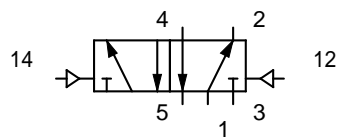
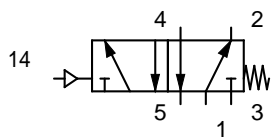
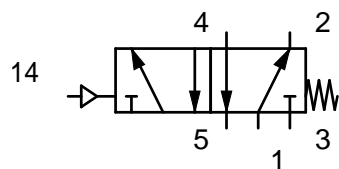
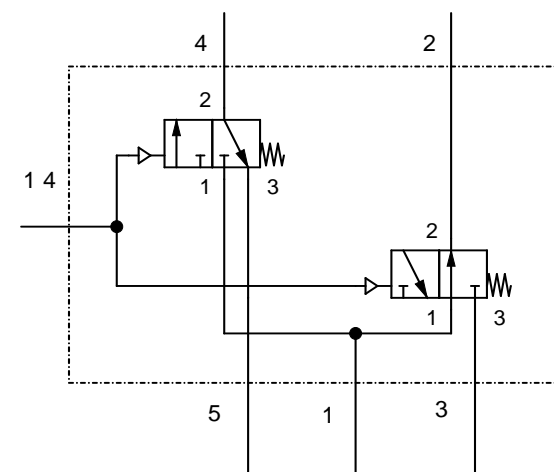

De verschillende ventieltypes

Het 5/2 ventiel

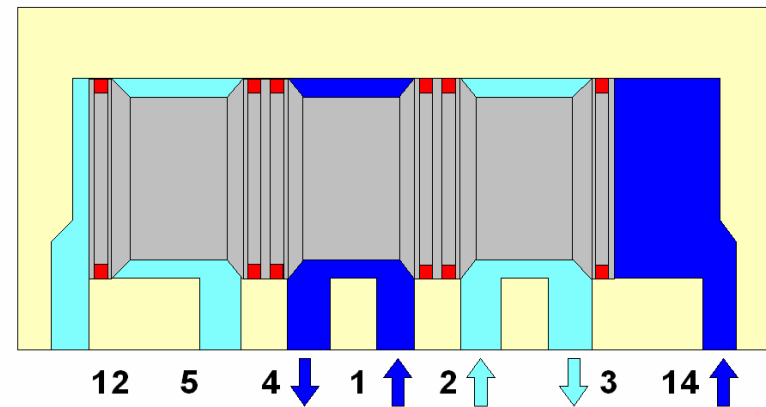
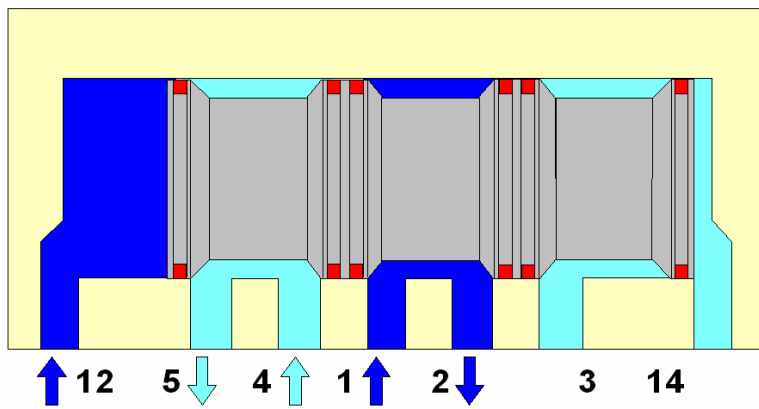
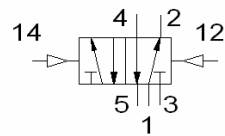

De verschillende ventieltypes

Het 4/3 ventiel

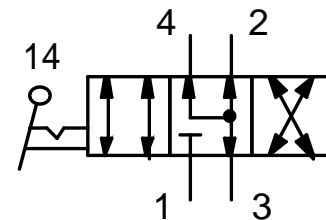
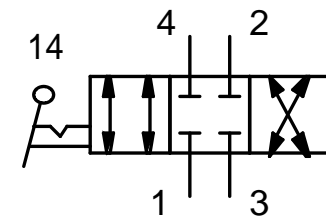
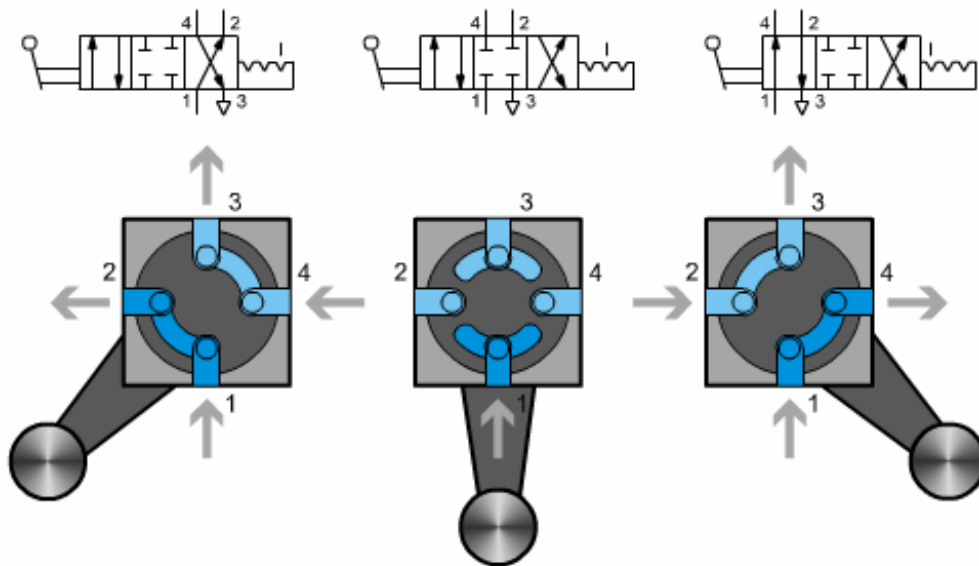

De verschillende ventieltypes

Het 5/3 ventiel

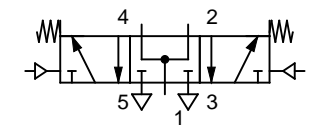
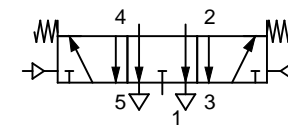
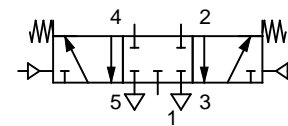
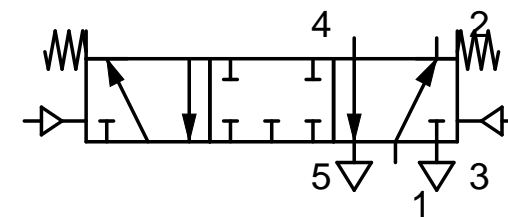
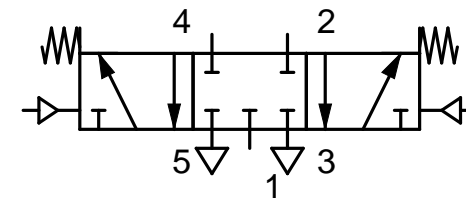
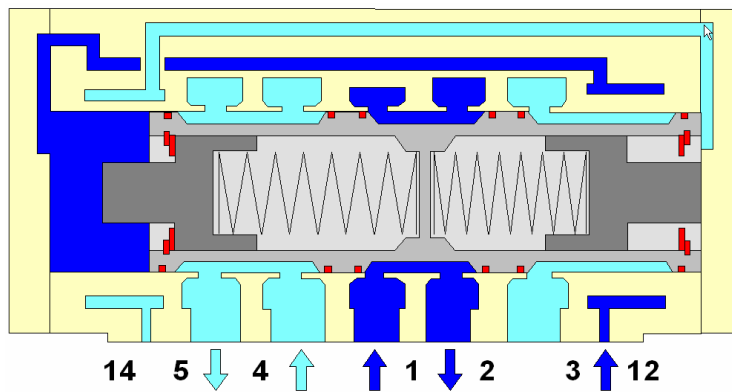
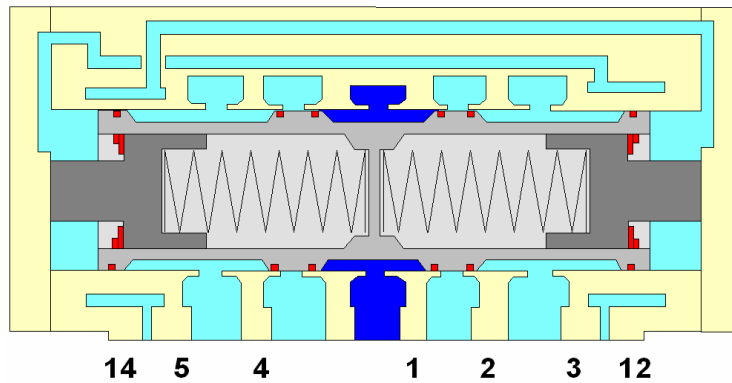

De constructie

Klepventielen

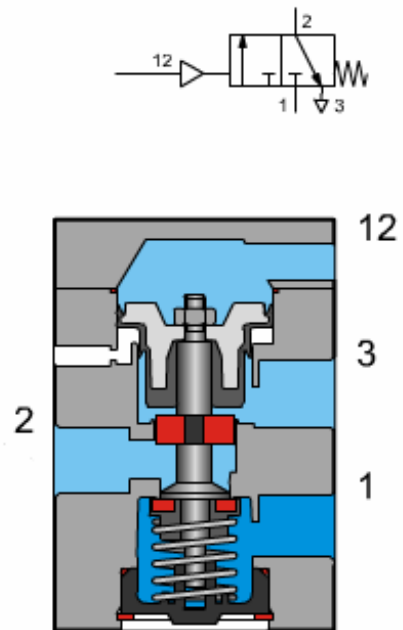

Schuifventielen

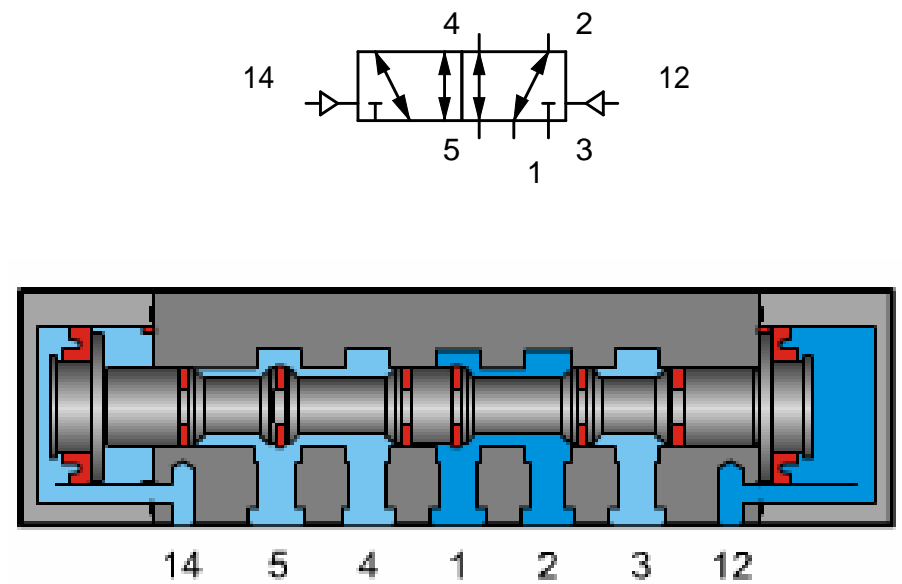

Overlappen

Positieve overlapping

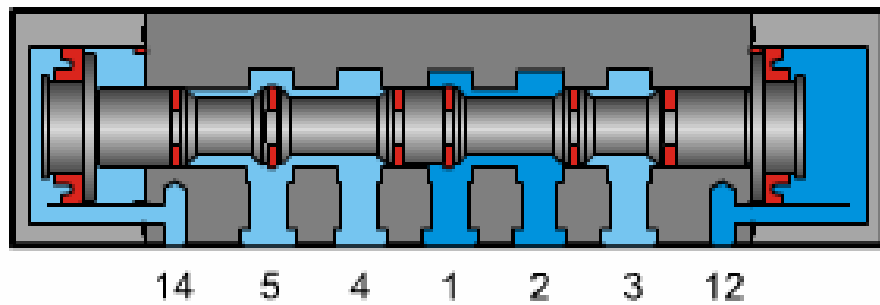

Negatieve overlapping

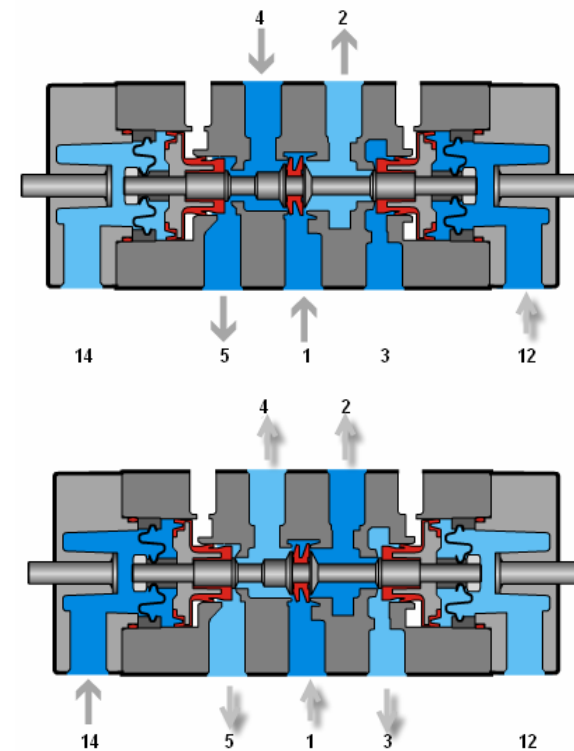

Indirect gestuurde ventielen

