

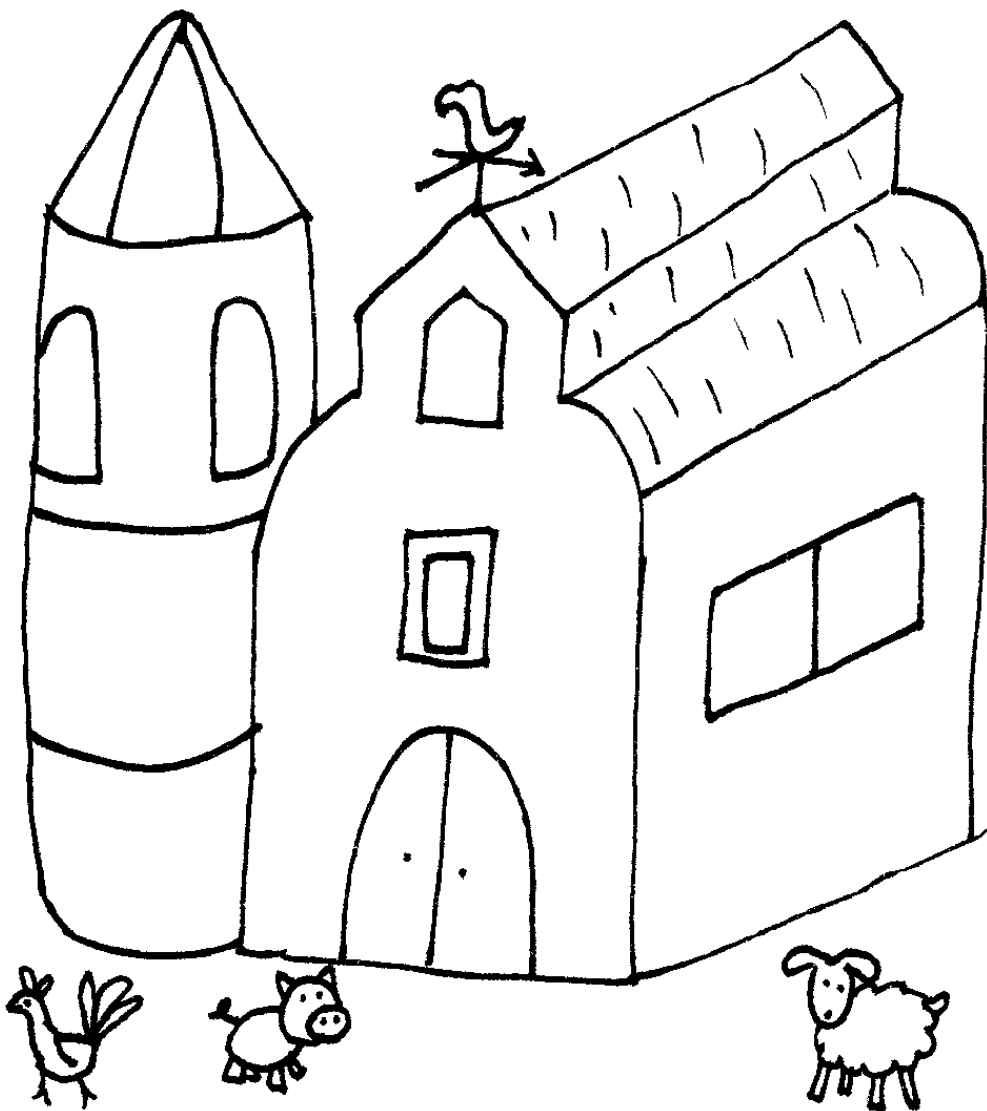

# werkboekje

## wonen



naam: \_\_\_\_\_

Teken 1 meer.

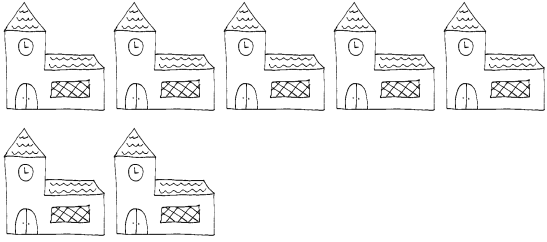
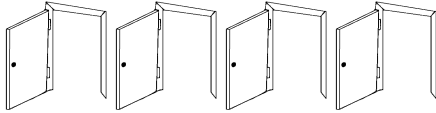
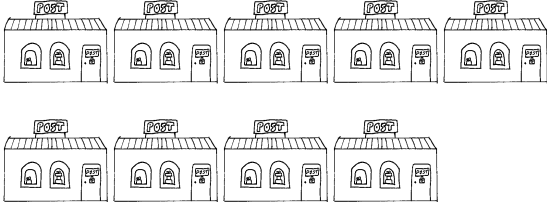
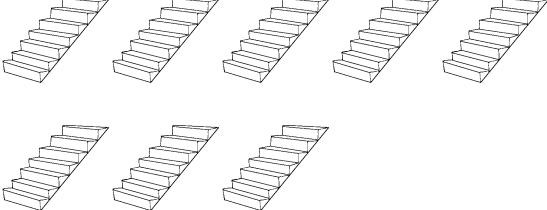
|   |  |
|---|--|
|    |  |
|    |  |
|   |  |
|  |  |
|  |  |



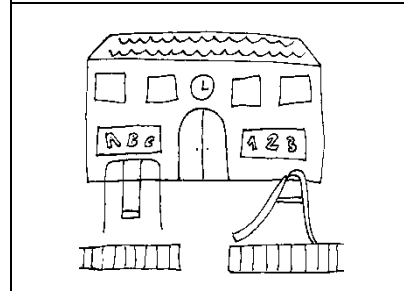
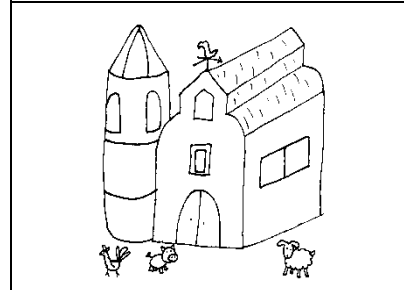
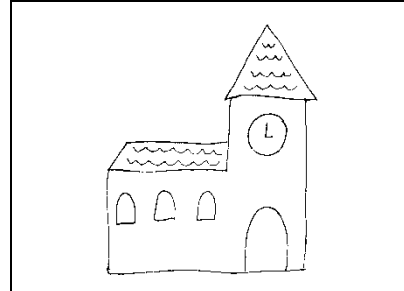
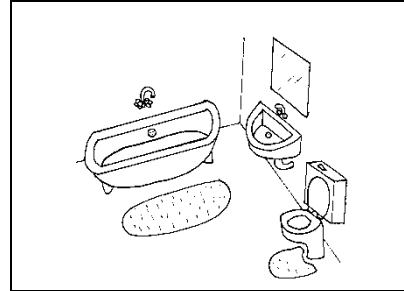
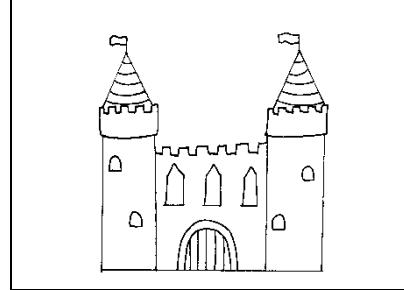
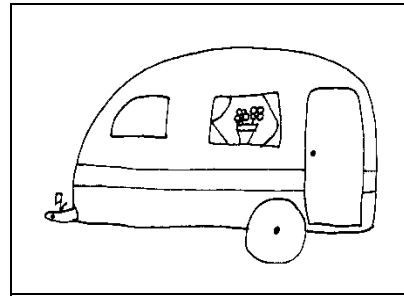
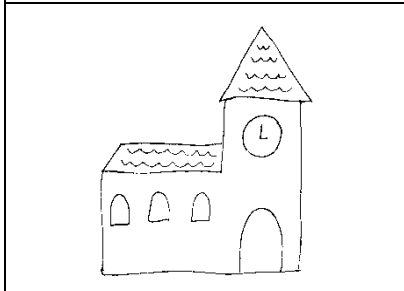
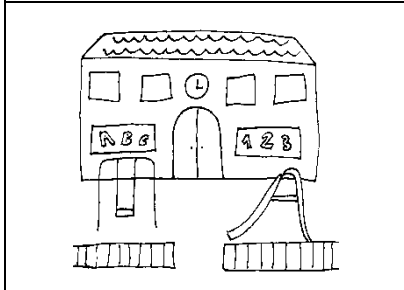
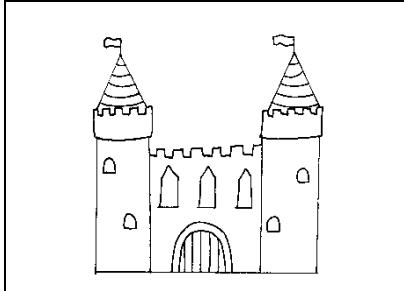
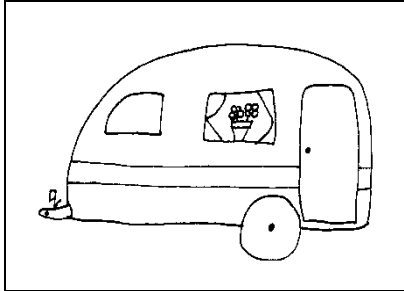
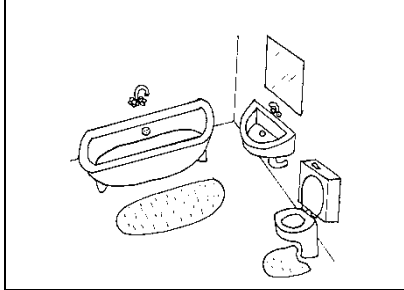
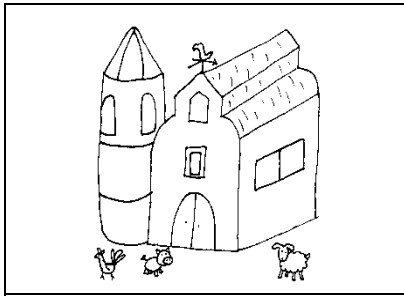

Verbind dezelfde plaatjes.

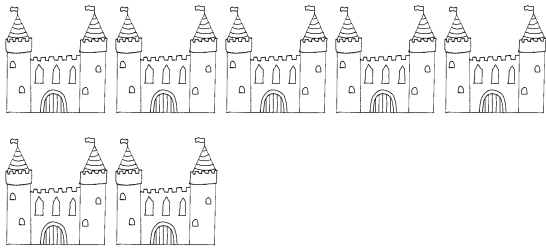

Omcirkel de eerste letter van het woord.

|   |         |             |
|---|---------|-------------|
|    | kasteel | m j t k l a |
|    | gordijn | s g r i d v |
|    | huis    | a p w i h k |
|   | flat    | f n d b u h |
|  | garage  | b l z g n e |
|  | winkel  | e b a f w c |
|  | fabriek | w p f t e d |
|  | toilet  | m s i h t k |

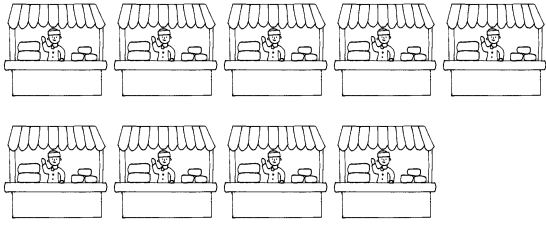
Hoeveel tel je?

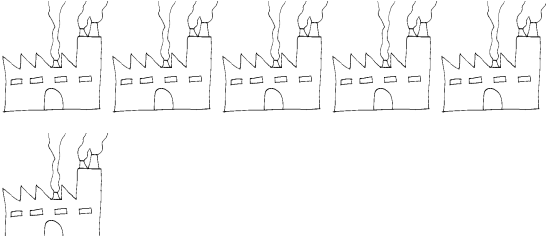
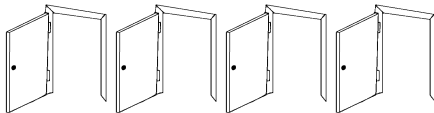
|   |                         |
|---|-------------------------|
|    | 1 2 3 4 5<br>6 7 8 9 10 |
|    | 1 2 3 4 5<br>6 7 8 9 10 |
|   | 1 2 3 4 5<br>6 7 8 9 10 |
|  | 1 2 3 4 5<br>6 7 8 9 10 |
|  | 1 2 3 4 5<br>6 7 8 9 10 |
|  | 1 2 3 4 5<br>6 7 8 9 10 |



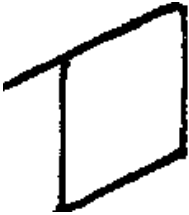
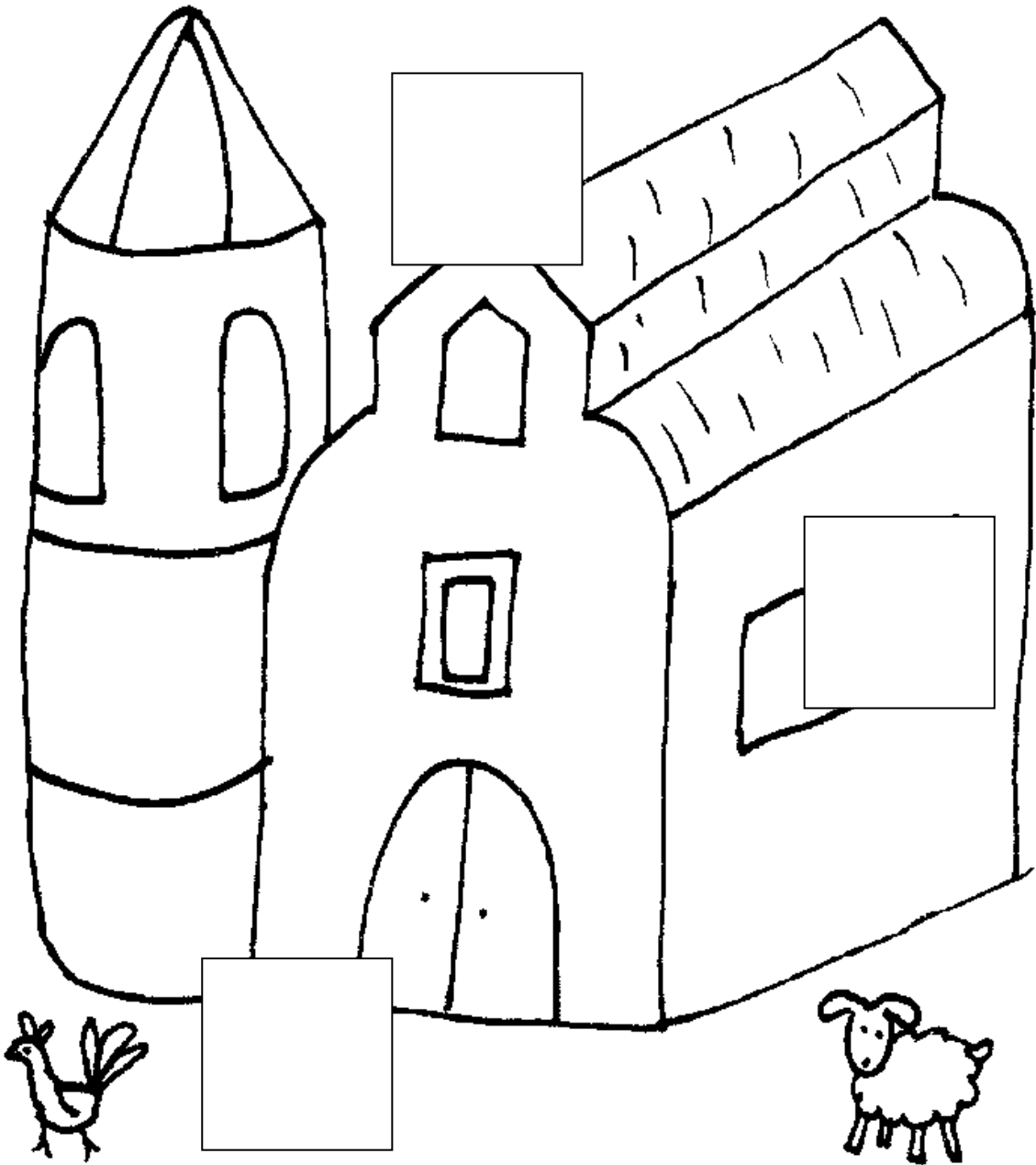

Welk stukje hoort waar?

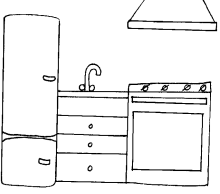
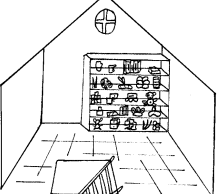
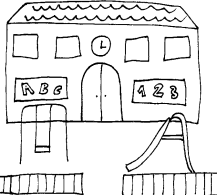
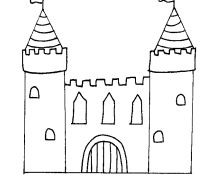
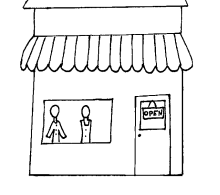
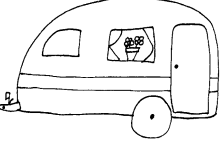

Omcirkel steeds hetzelfde woord.

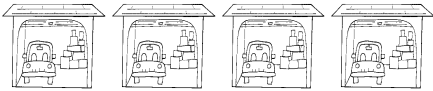
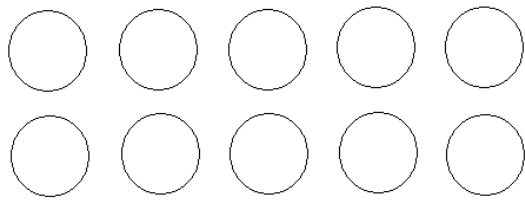
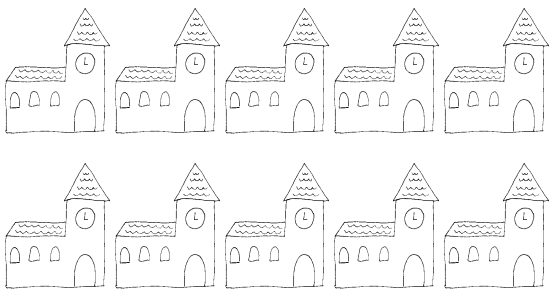
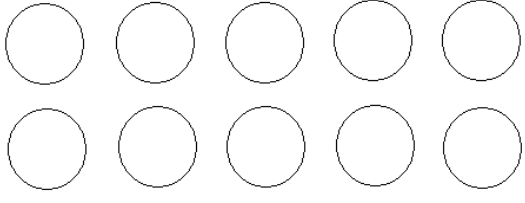
|   |                       |  |
|---|-----------------------|--|
|    | <p><b>keuken</b></p>  | <p>kekeun keeukn kkeuen<br/>keuken keeukn kenuke</p>       |
|    | <p><b>zolder</b></p>  | <p>zodler zeoldr zoerld<br/>olzder zolder zerold</p>       |
|   | <p><b>school</b></p>  | <p>school oschol scoolh<br/>shcool scoohl soochl</p>       |
|  | <p><b>kasteel</b></p> | <p>kstaeel kasteel keastel<br/>katseel steekal keastel</p> |
|  | <p><b>winkel</b></p>  | <p>ewinkl wiknel wkeinl<br/>weinkl winkel wielnk</p>       |
|  | <p><b>caravan</b></p> | <p>cravaan cavaarn caanrav<br/>caravan cavanra caravan</p> |

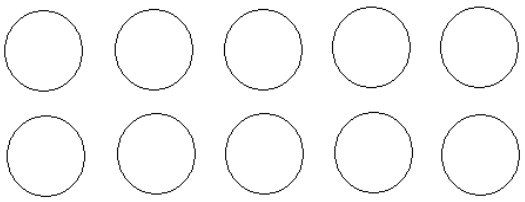
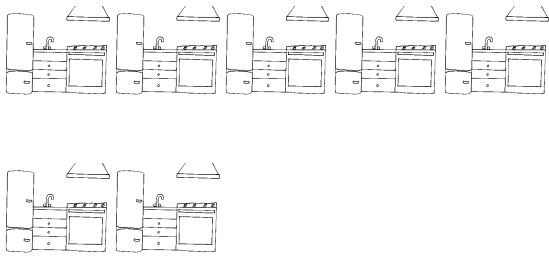
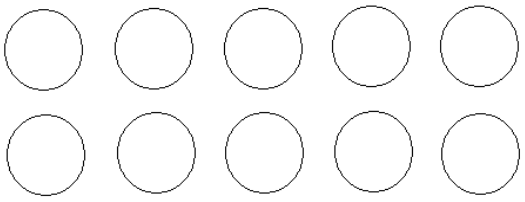
Kleur steeds evenveel.

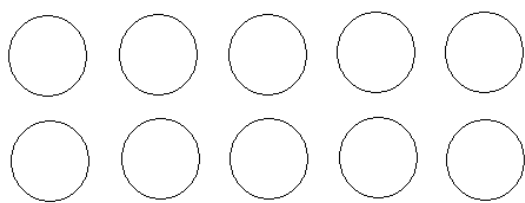
|   |  |
|---|--|
|    |    |
|    |    |
|   |  |
|  |  |
|  |  |



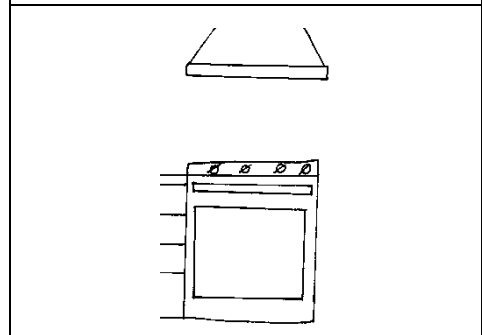
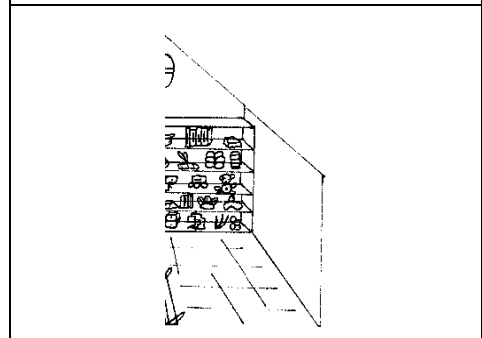
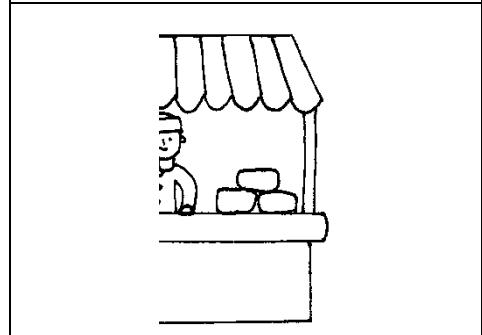
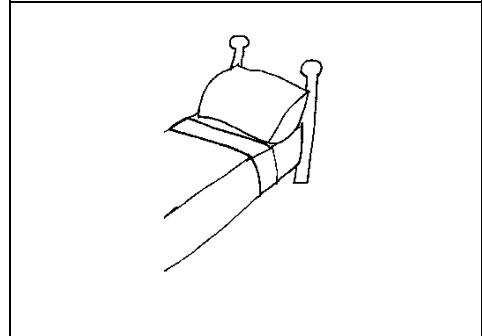
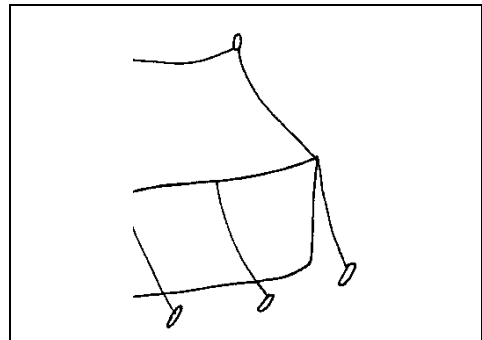
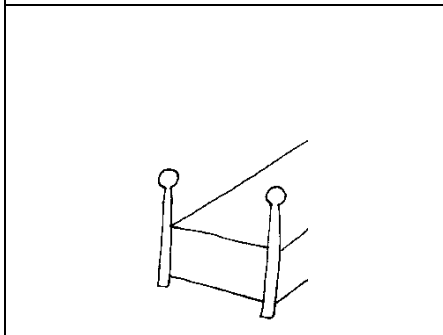
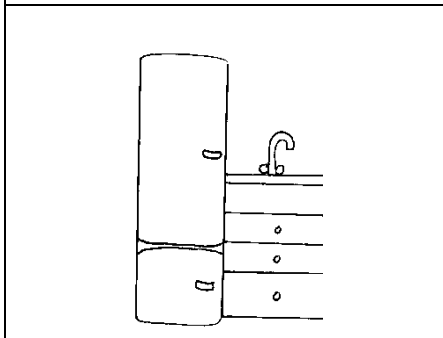
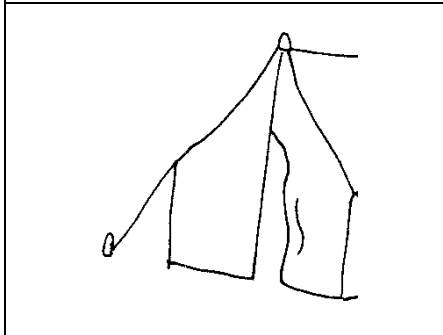
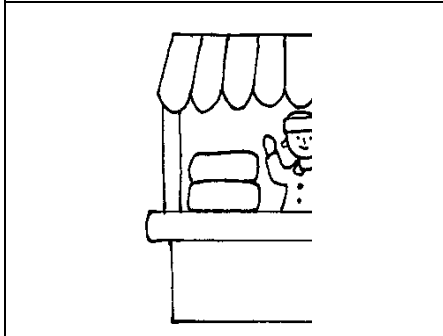
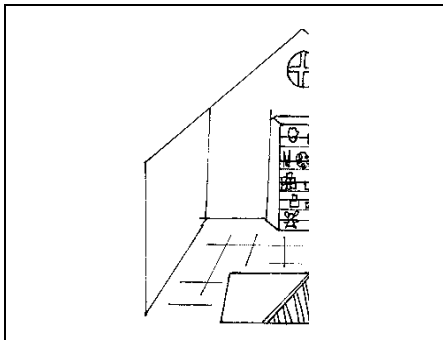

Verbind de plaatjes die bij elkaar horen.

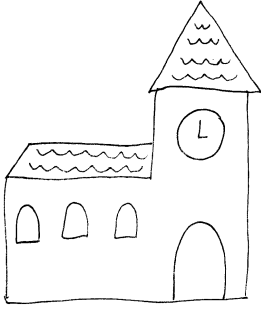
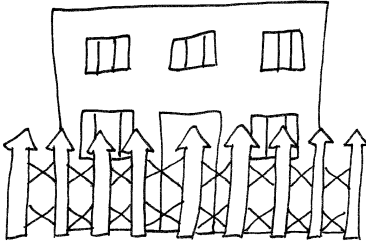
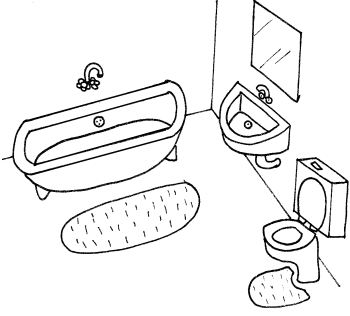

Kleur voor elke lettergreep een stip.

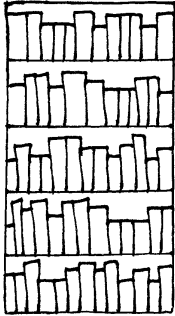
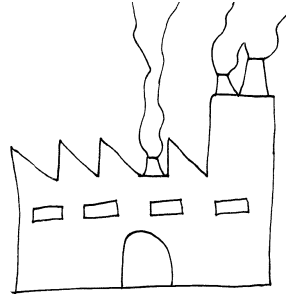
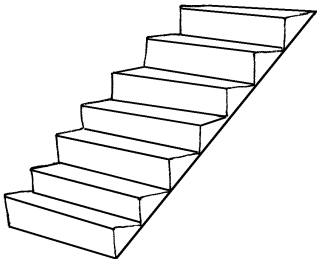
|   |   |   |
|---|---|---|
|  |  |  |
| kerk  | gevangenis  | badkamer  |
| ○ ○ ○ ○ ○   | ○ ○ ○ ○ ○   | ○ ○ ○ ○ ○   |

|  |  |  |
|--|--|--|
|  |  |  |
| boekenkast   | fabriek  | trap   |
| ○ ○ ○ ○ ○  | ○ ○ ○ ○ ○  | ○ ○ ○ ○ ○  |

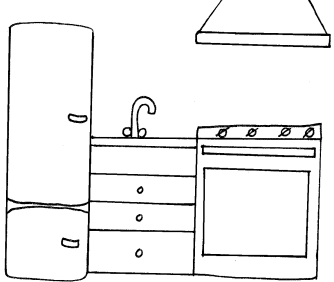
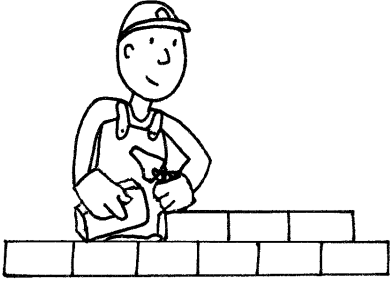
|   |   |   |
|---|---|---|
|  |  |  |
| wasbak  | keuken  | metselaar   |
| ○ ○ ○ ○ ○   | ○ ○ ○ ○ ○   | ○ ○ ○ ○ ○   |